



CADprofi 2025

Summary of main changes made in the program
since the CADprofi 2024.01 version.



CADprofi

Table of contents:

- [General functions \(all modules\)](#)
- [CADprofi Architectural](#)
- [CADprofi Electrical](#)
- [CADprofi HVAC & Piping](#)
- [CADprofi Mechanical](#)
- [Product library](#)
- [Compatibility with CAD programs](#)

✓ CADprofi – extending the “Numbering” command

In the latest version of CADprofi program the **Numbering**  command has been expanded

Currently the program enables the renumeration, including:

- moving the numbers in numbering sequences,
- removing the gaps in numbering,
- removing the whole numbering sequence,
- geometrical renumeration,
- modification of the number's format.

Furthermore the following options has been added to the command:

- formatting the numbers by adding the leading zeros,
- numbering the sequences of the pipes/channels/trays,
- fixing the copied objects numbered by their renumeration.

Additionally after detecting ambiguities in numbering, program informs about the lack of connections between objects and numbers and allows their synchronization. The "Repair" button displays a dialog box with options for this synchronization. User can:

- recover the number or remove numbering information from the object or its copy,
- remove nonassociated numbers.

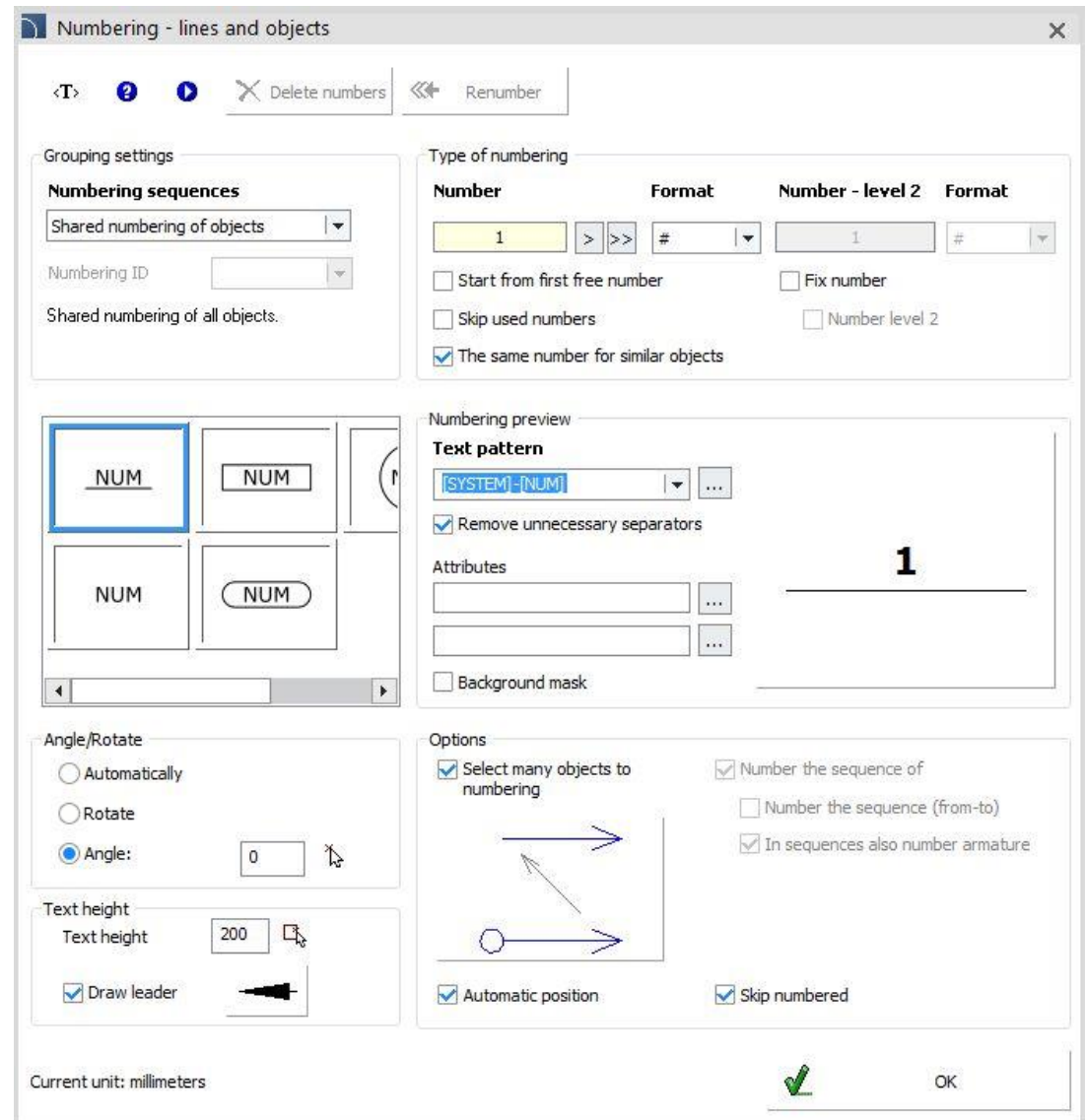

✓ CADprofi – drawing wire harnesses

CADprofi program has been expanded with a new functionality for drawing schematic lines. The latest version of the program introduces the ability to draw wire harnesses, which improves the design and visualization of, among others, connections in electrical and hydraulic schemes.



[Watch movie](#)

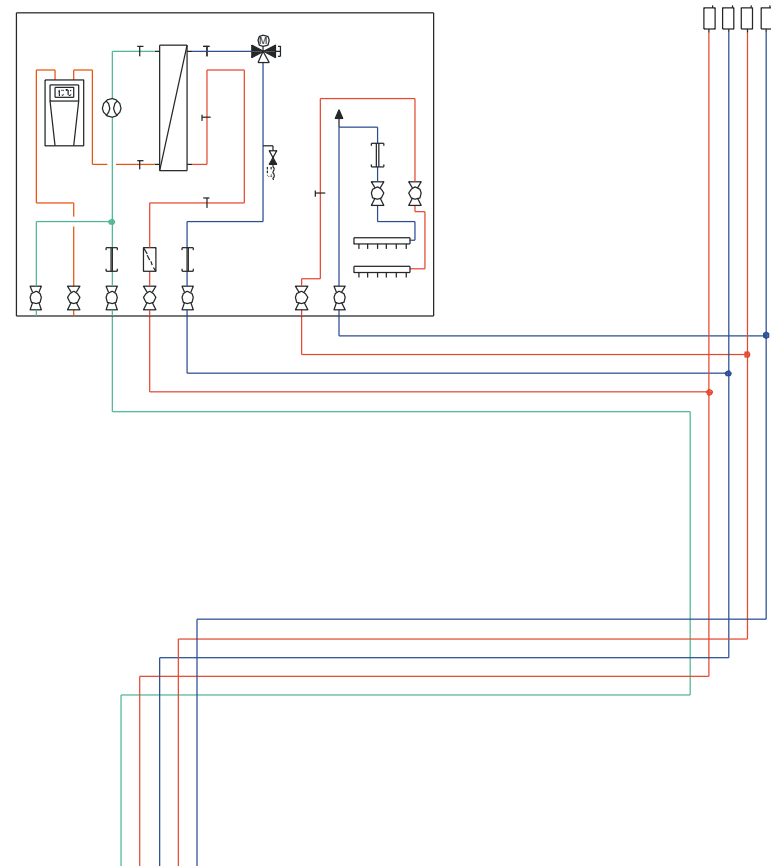

✓ CADprofi – new improvements in scheme creator

In the electrical scheme creator and libraries that contain central heating calculations with decentralized domestic hot water preparation stations (Uponor, Strawa and others), the ability to edit schemes by using the "drag and drop" technique has been added. Thanks to this, it is possible to conveniently move, copy or swap symbols by using the mouse.

Holding the left mouse button on a symbol allows user to drag it to a new location.

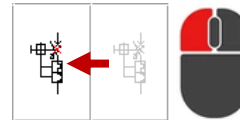

Holding the left mouse button with the **Ctrl** key pressed allows user to copy the symbol to a new location.



Holding the left mouse button with the **Shift** key pressed allows user to swap symbols.



Additionally, two new keyboard shortcuts have been introduced in the scheme creator:

- **Ctrl + Z** (undo the last operation).
- **Ctrl + Y** (repeat the last operation).

Additionally, the electrical scheme creator has been expanded with the ability to move, copy or swap columns by using the "drag and drop" technique.

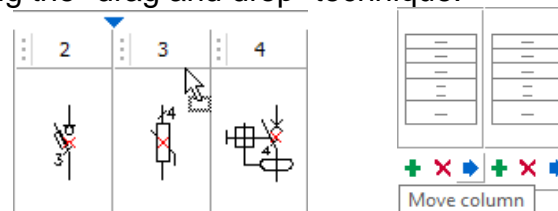

[Watch video](#)

✓ CADprofi – improved searching (auto-filling)

In the latest version of the CADprofi program the improved searching of the objects in dialog boxes has been implemented. Now the program prompts the names of elements included in the database during the typing of the text.

This new option is available in the following commands:

- Pipes - scheme,
- Walls,
- Symbols.

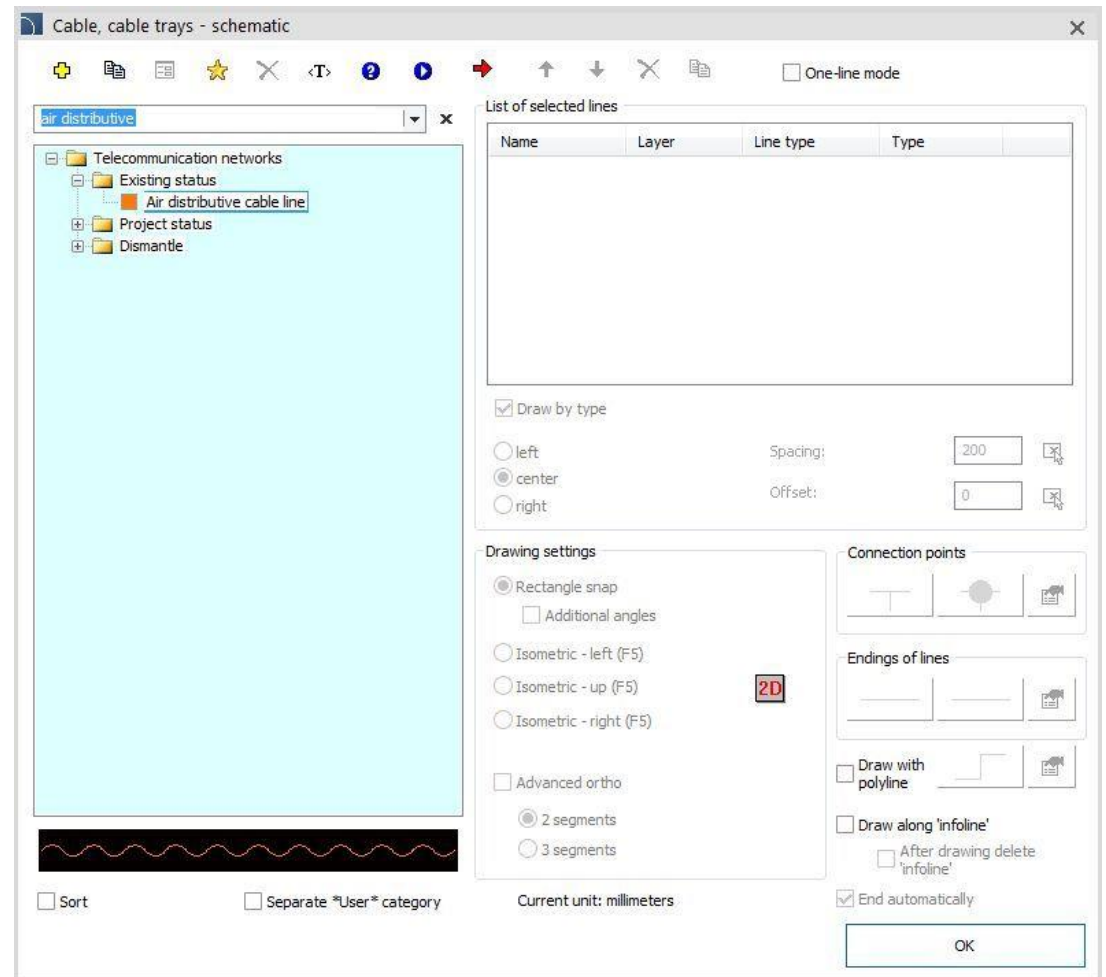

✓ CADprofi – tooltips in dialog boxes

Dialog windows of the CADprofi program allow user to display tooltips on how to write/read data in the object, e.g. as Attribute, User parameters, etc. Thanks to this, when filling in data and creating specifications, user can more easily identify their source.

Article	LOGO! 24CE, 8DI(4AI)/4DO
Attribute: ARTICLE	Siemens
Catalogue number	6ED1052-1CC08-0BA0
Other:	

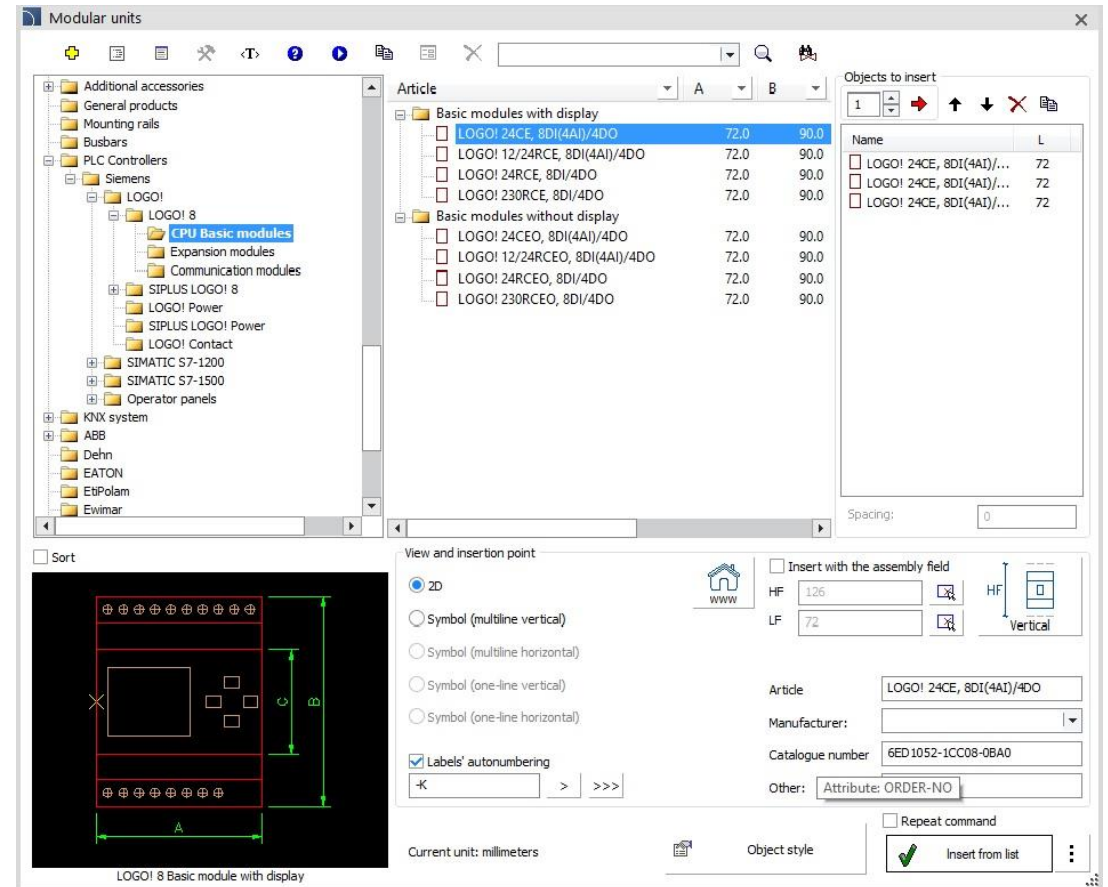

The screenshot displays the 'Modular units' dialog box in CADprofi. The left pane shows a hierarchical tree of Siemens LOGO! modules. The middle pane shows a table of selected items:

Article	A	B
LOGO! 24CE, 8DI(4AI)/4DO	72.0	90.0
LOGO! 12/24RCE, 8DI(4AI)/4DO	72.0	90.0
LOGO! 24RCE, 8DI/4DO	72.0	90.0
LOGO! 230RCE, 8DI/4DO	72.0	90.0
LOGO! 24CEO, 8DI(4AI)/4DO	72.0	90.0
LOGO! 12/24RCEO, 8DI(4AI)/4DO	72.0	90.0
LOGO! 24RCEO, 8DI/4DO	72.0	90.0
LOGO! 230RCEO, 8DI/4DO	72.0	90.0

The bottom panel shows configuration options for the selected item:

- View and insertion point: 2D
- Symbol options: Symbol (multiline vertical), Symbol (multiline horizontal), Symbol (one-line vertical), Symbol (one-line horizontal)
- Labels' autonumbering:
- Dimensions: HF 126, LF 72
- Article: LOGO! 24CE, 8DI(4AI)/4DO
- Manufacturer: Siemens
- Catalogue number: 6ED1052-1CC08-0BA0
- Other: Attribute: ORDER-NO

A tooltip is visible over the 'Attribute: ARTICLE' field, displaying 'Siemens'. The bottom status bar indicates 'Current unit: millimeters' and 'Object style: Insert from list'.

✓ CADprofi – inserting cross symbols in polylines

The functionality of inserting cross symbols has been extended in the CADprofi program. Until now, such symbols could only be inserted into intersecting lines. Currently, the program allows user to insert cross symbols also into intersecting polylines and into a line intersecting with a polyline.

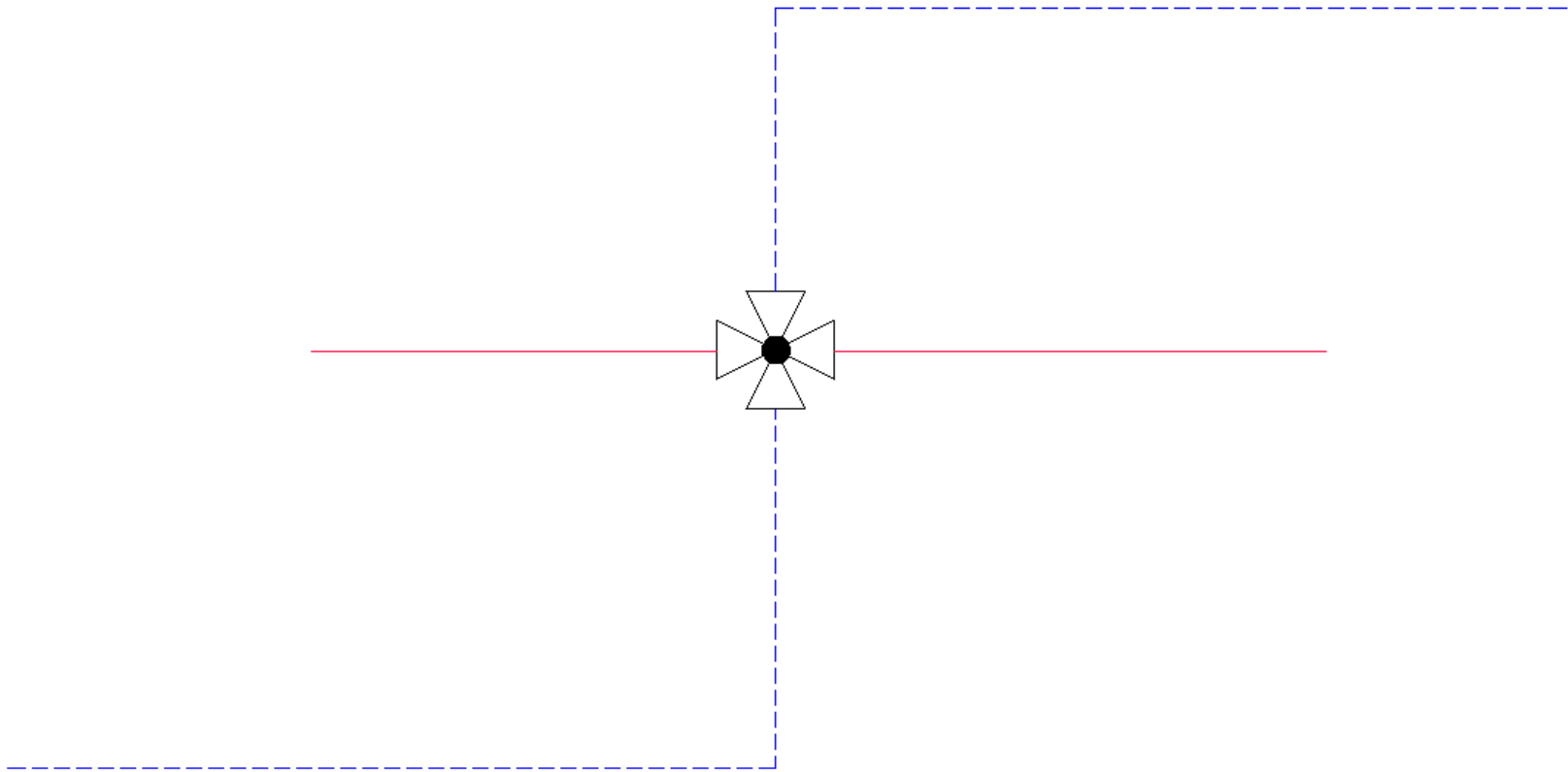



CADprofi

✓ CADprofi – links to video tutorials directly in the program

A button has been added to the CADprofi program dialog windows, allowing user to quickly go to the appropriate video showing how to use a given command. Video tutorials show step by step how to create projects using the CADprofi add-on.

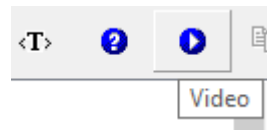

CADprofi Architectural movie

Quick skip to movie scene:

- Drawing single and multi-layered walls
- Chimneys, culverts and gravity ventilation
- Inserting woodwork (doors and windows)
- Room definitions
- Designing stairs
- Furniture and equipment library
- Designing roofs
- Architectural dimensioning
- Cross-section and elevation views
- Roof gutter system
- Spot height and topographic signs
- Creating specifications and legends
- Preparation for printing

Watch full movie:



✓ CADprofi Architectural – railings

CADprofi Architectural has been extended with a new **Railings**  command. This command contains railings for balconies and terraces in top and front views.

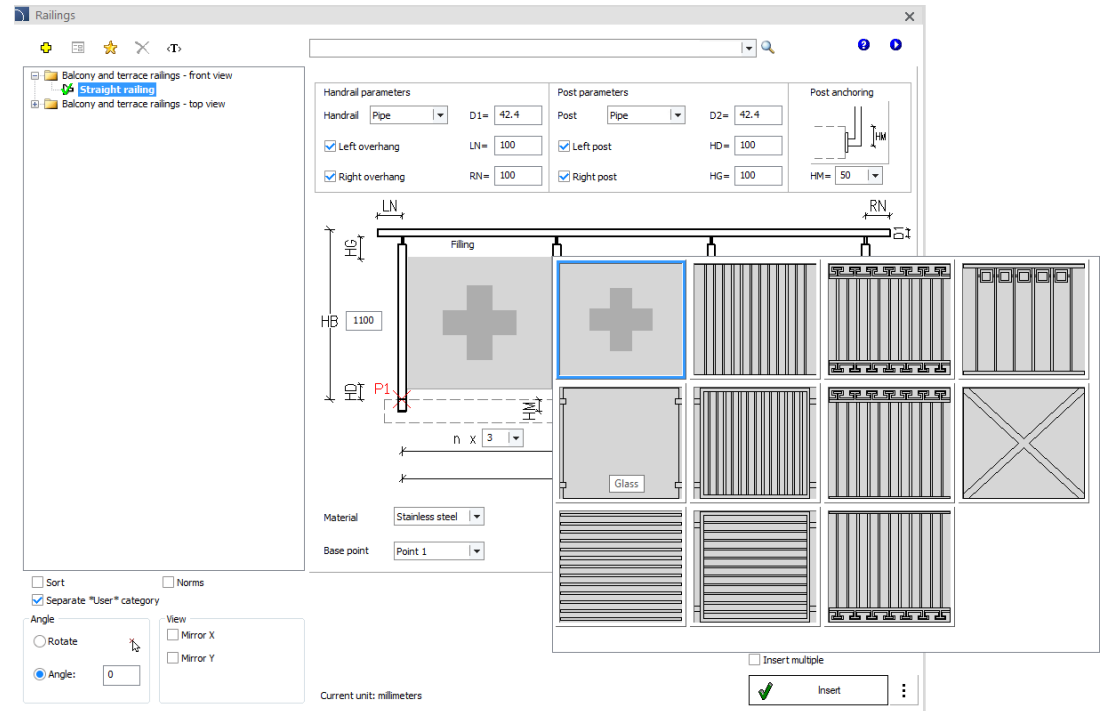
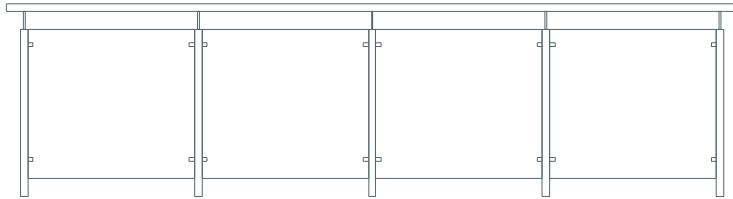

✓ CADprofi Architectural – external architecture

Architectural module of the CADprofi program has been expanded by the new command **External architecture** . This command includes:

- Terrace pergolas.
- Terrace shelters, garden shelters and garage shelters.
- Garden gazebos, garden houses for tools.
- Tunnels and garden greenhouses.
- Garden furniture (seats, sofas, tables, garden furniture sets).
- Flowerpots.
- External lighting (garden lamps, external wall lamps, lanterns).
- Grills and furnaces.
- Playgrounds (sets, houses for children, swings, slides, playgrounds, sports equipment).
- Garden saunas, external jacuzzi.
- Greengrocer's, ponds.
- Small architecture (wastebaskets, benches, information boards, information pillars, bicycle stands).
- Panel fences, concrete, prefabricated block, mesh.
- Gates and wickets.
- Fence posts.

Additionally elements from other commands, eg.: pools, plants, containers for the waste, vehicles has been moved to this command.

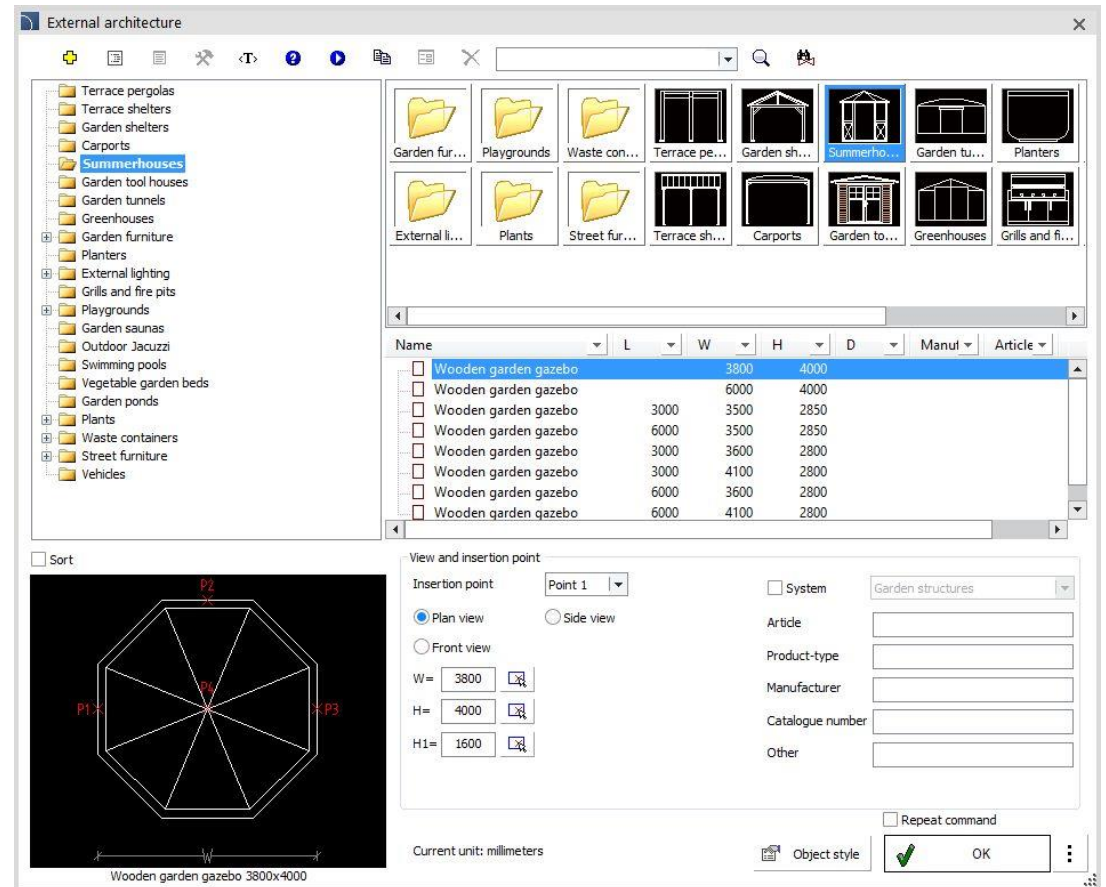

✓ CADprofi Architectural – free standing and wall cabinets

Free standing and wall kitchen furniture has been added to the **Furniture and equipment**  command, including:

- cabinets with 2, 3 and 4 drawers,
- built-in oven cabinets,
- cabinets for built-in refrigerators and freezers,
- corner built-in cabinets,
- built-in sink cabinets,
- wall cabinets
- cabinets with solid doors
- cabinets with solid and glass doors,
- cabinets with pull-out cargo,
- cabinets with doors and drawers,
- cabinets with utility interior,
- horizontal cabinets,
- hood cabinets,
- microwave cabinets,
- cabinets above the fridge,
- cabinets with a drainer for dishes,
- open cabinets.

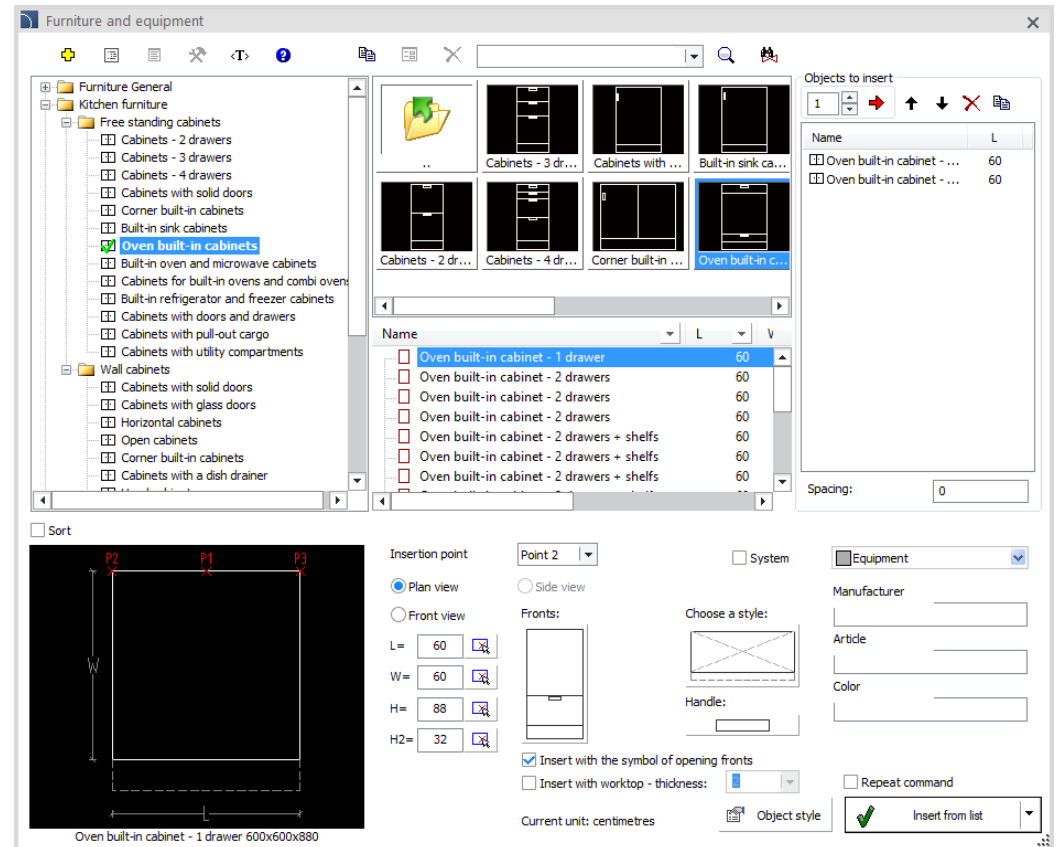

✓ CADprofi Architectural – expanding the „Woodworks” command

The **Woodworks**  command has been expanded with the following new features:

- Possibility to determine the distance of the door frame from the wall edge. This allows the door to be properly mounted, e.g. in walls with a layer of external insulation.
- The opening angle of the door.

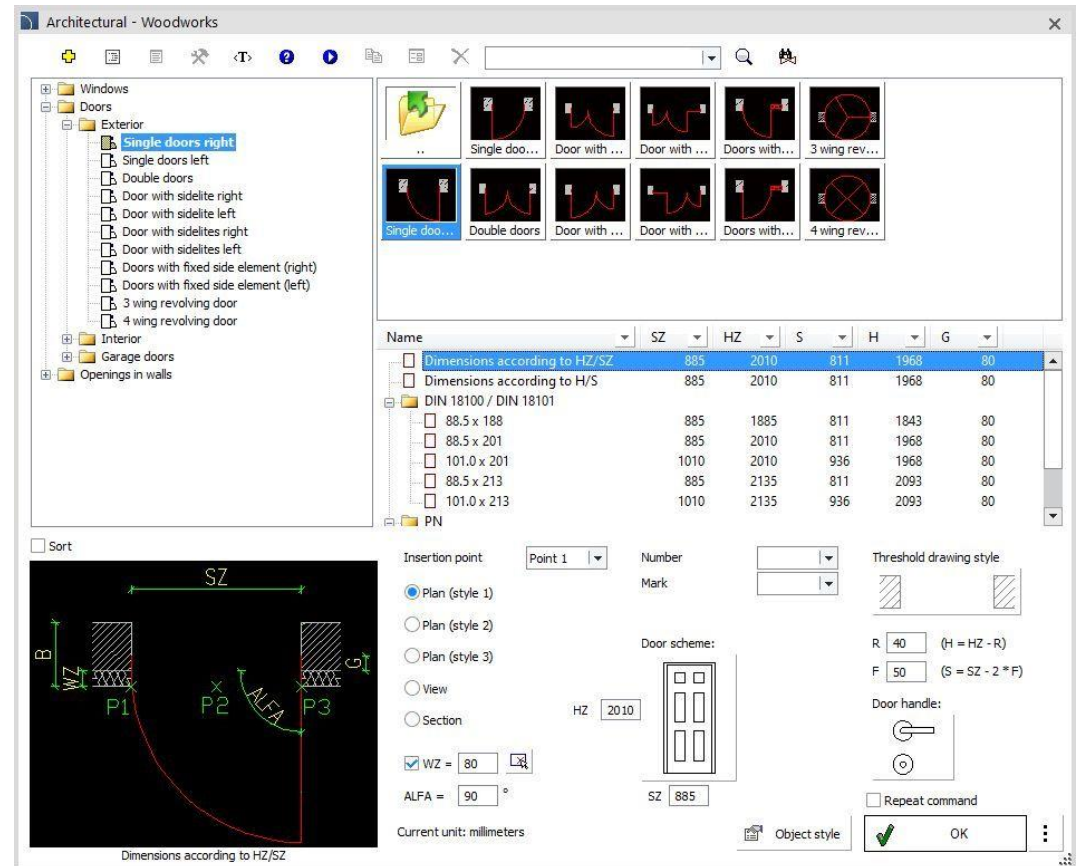

Name	SZ	HZ	S	H	G
Dimensions according to HZ/SZ	885	2010	811	1968	80
Dimensions according to H/S	885	2010	811	1968	80
DIN 18100 / DIN 18101					
88.5 x 188	885	1885	811	1843	80
88.5 x 201	885	2010	811	1968	80
101.0 x 201	1010	2010	936	1968	80
88.5 x 213	885	2135	811	2093	80
101.0 x 213	1010	2135	936	2093	80
PN					

WZ = 80
ALFA = 90°

Door scheme:
HZ = 2010
SZ = 885

Threshold drawing style:
R = 40 (H = HZ - R)
F = 50 (S = SZ - 2 * F)

Current unit: millimeters

✓ CADprofi Electrical – dynamic determination of the protection zone for masts

Dynamic determination of lightning protection areas for a multi-mast system using the rolling ball method for four LPS protection classes has been added to CADprofi Electrical program. Program main features:

- designation and visualization of the protection zone at given heights and a specific LPS class for selected masts using the rolling ball method,
- possibility of designating several 'isolines' for different heights of the protection zone,
- determining the top penetration for masts in side view;
- taking into account different heights of masts and their installation height;
- automatic update of protection zones when moving, deleting or copying masts;
- automatic calculation of the optimal distance between masts for the **Arrange** function,
- protection zones with dedicated layer types containing information about their heights.

Additionally, the **Lightning Protection Systems**  command has been expanded to include collapsible grounding pins and the ability to add additional accessories for main products, e.g. heads for high-voltage cables for cross connectors or gutter holders for down conductors.



View and insertion point

Top view Side view

Height of protection zones [m]:

H1= H2= H3=

Height of mast mounting [m]: H0=

Description:

Description height:

Dimensioning:

Protection class:

Current unit: millimeters 

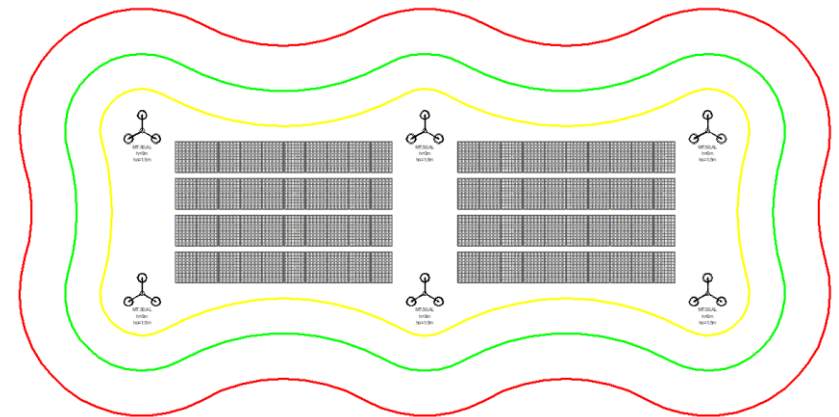

Dynamic determination of lightning protection areas is available in the latest versions of AutoCAD, BricsCAD, GstarCAD and ZWCAD.

✓ CADprofi Electrical – expanding the busbars library

The **Busbars and cable trays**  command has been expanded with additional product categories:

- Transformers (resin, oil);
- Switchgear;
- Flexible connections (for dry-type resin and oil transformers).

Additionally, the connectors category has been expanded with adjustable connectors with angles from 60 to 90 and from 90 to 179 degrees.

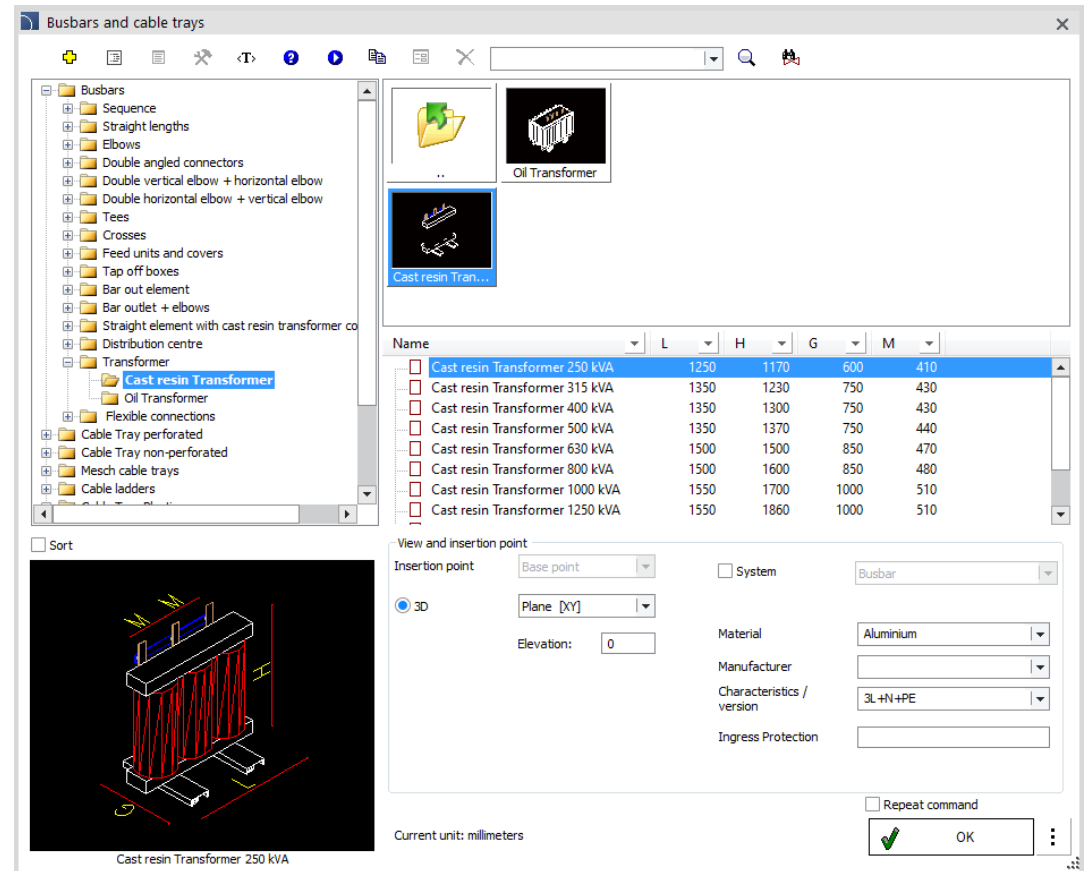

✓ CADprofi Electrical – extension of the library of switchboards and IEC, NFPA symbols

The **Switchboard**  command has been extended to include additional product types:

- surface-mounted and flush-mounted switchboards, 1 row, 18 and 22 modules;
- surface-mounted and flush-mounted switchboards, 4-7 rows (36 modules/row).

Additionally, the **IEC, NFPA Symbols**  library has been expanded with new symbols.

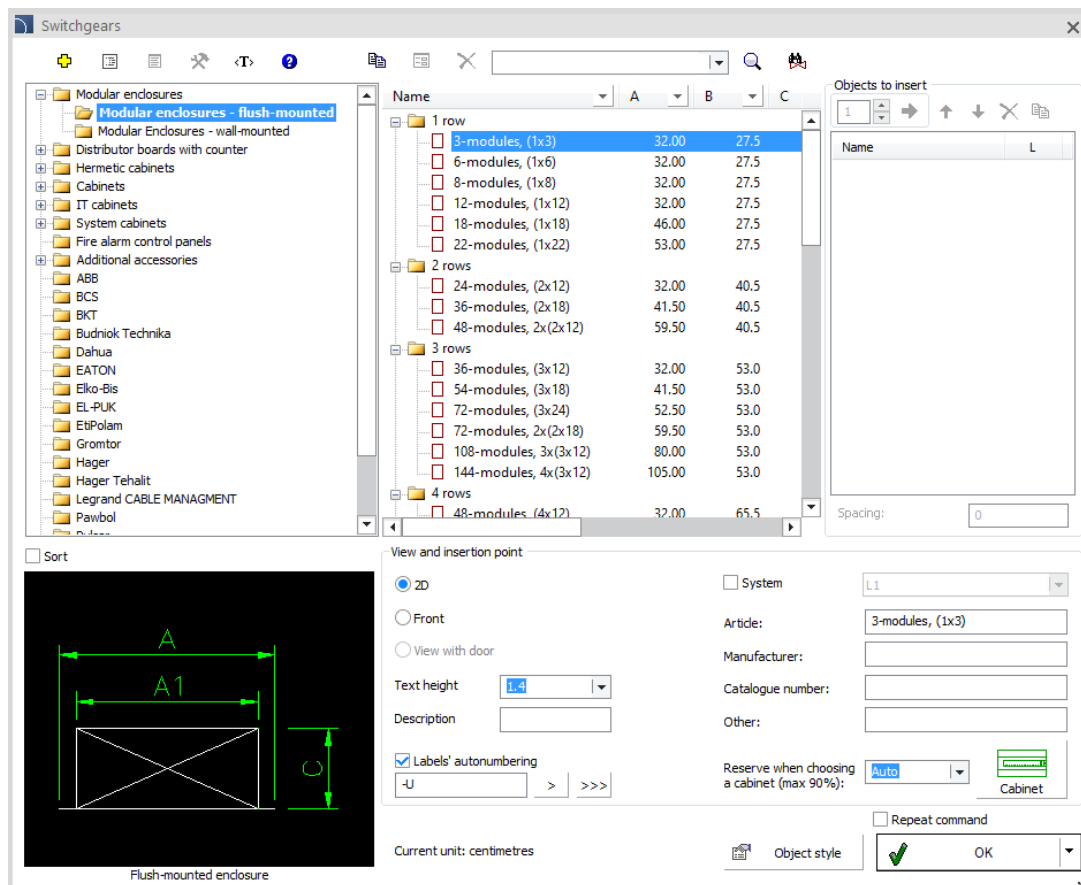
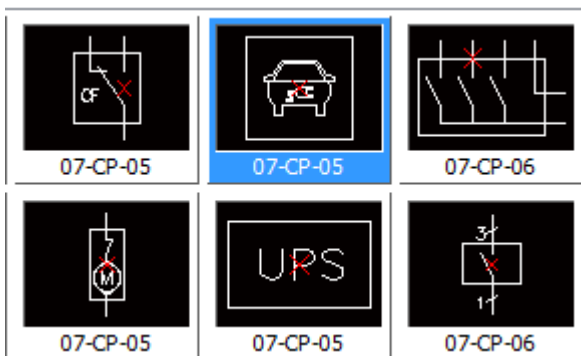

✓ CADprofi HVAC & Piping – expanding the „Schemes” command

The **Schemes**  command new systems have been added from the C.H. Installations category, including:

- DHW preparation circuits;
- Buffer systems;
- Pump groups;
- Safety groups;
- Boiler connections;
- Boiler rooms.

This command has also been expanded with new categories:

- Solar installations;
- Heat pump installations;
- Drinking water installations;
- Water intakes and treatment plants.

The expanded library of schemes now includes a wide selection of the most common systems and sample ready-made installation designs.

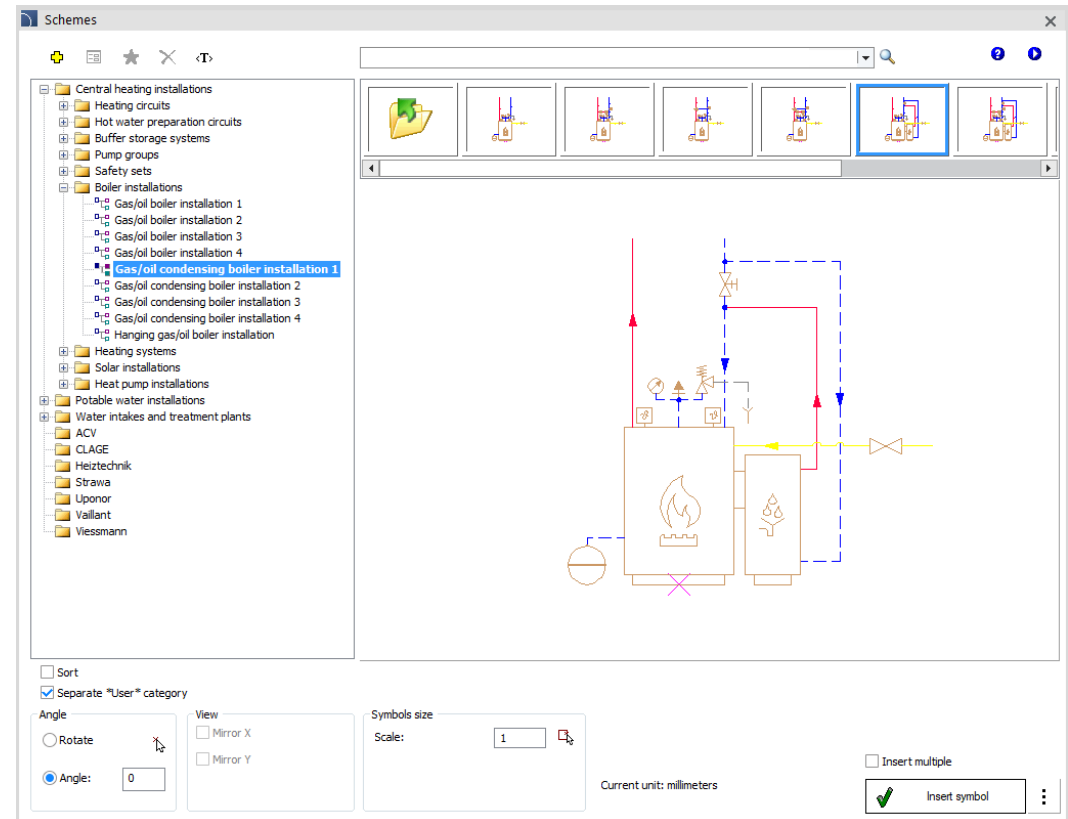

✓ CADprofi HVAC & Piping – expanding the „Pipes – scheme” command

The **Pipes – scheme**  has been expanded with a new category of pipelines - *water treatment*.

This category provides typical lines used in water intake and treatment plant schemes, such as: raw water, aerated water, treated water, and others.

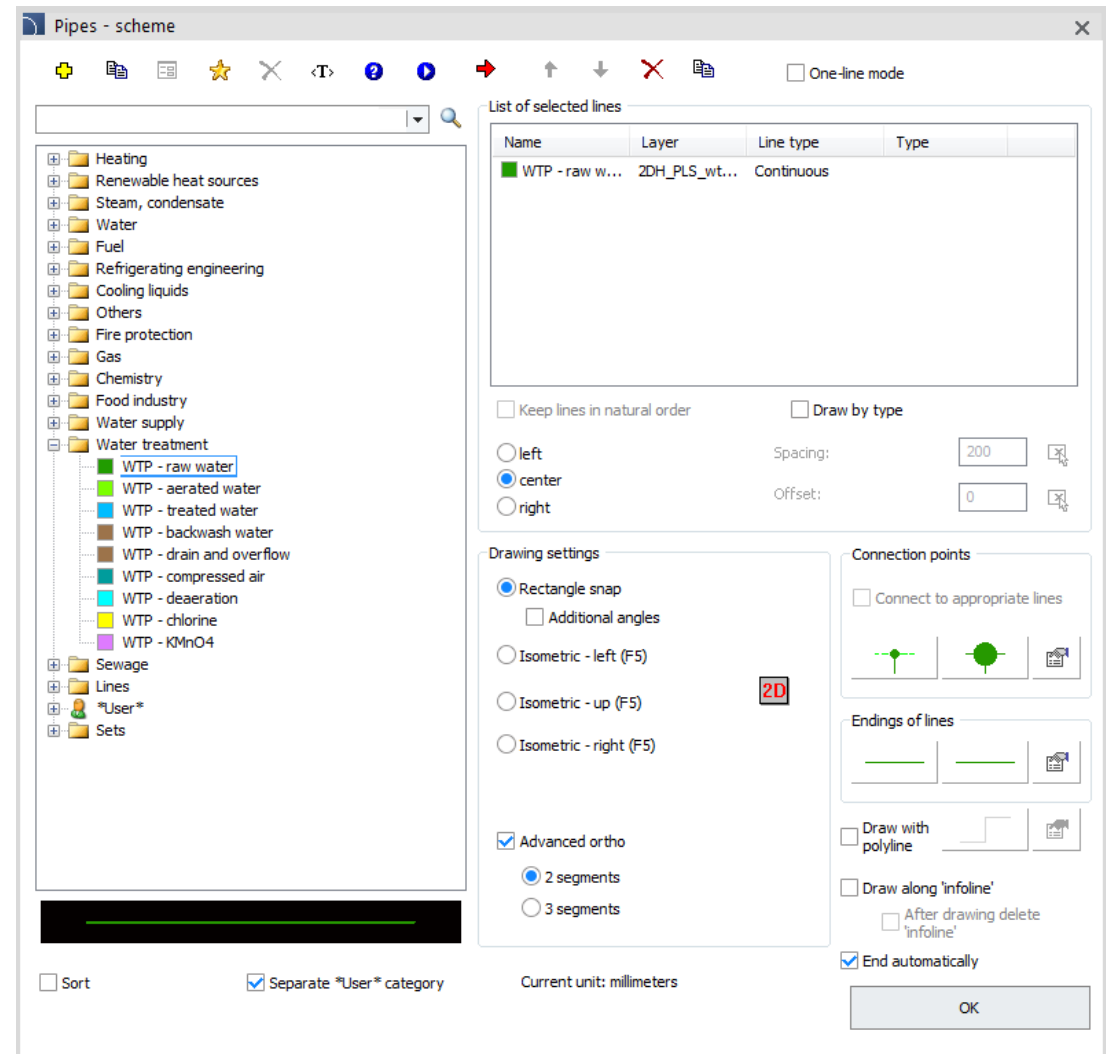

✓ CADprofi HVAC & Piping – extension of the flange fittings library

Gate valves without drives and *Drives for gate valves* have been added to the *Parametrical armature* command as separate objects:

- Manually operated wedge gate valves;
- Wedge gate valves for electromechanical drive;
- Gate valves for house connections;
- Handwheels for gate valves;
- Rigid housings for gate valves;
- Telescopic housings for gate valves.

Additionally, a list of available *wedge gate valves with handwheel* has been enriched with new types according to the Hawle catalogue.

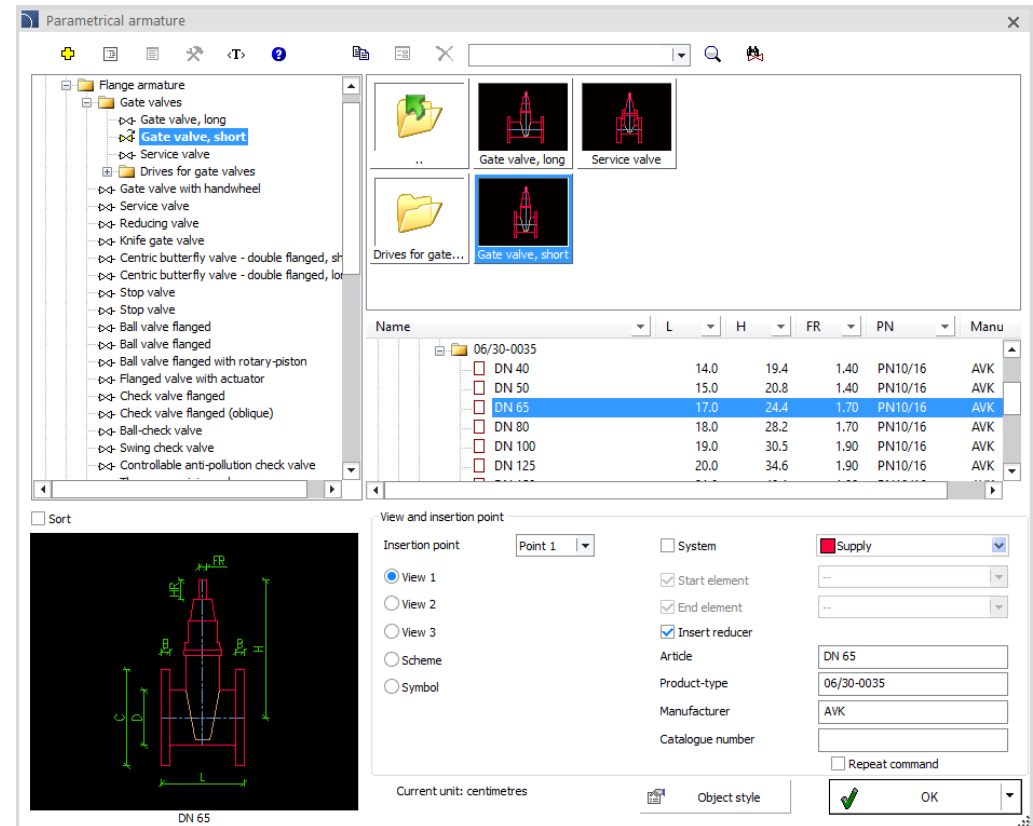

✓ CADprofi Mechanical – shaft generator



CADprofi Mechanical has been extended with a new **Shaft Generator**  command, which allows to automatically generate shafts from user-selected components.

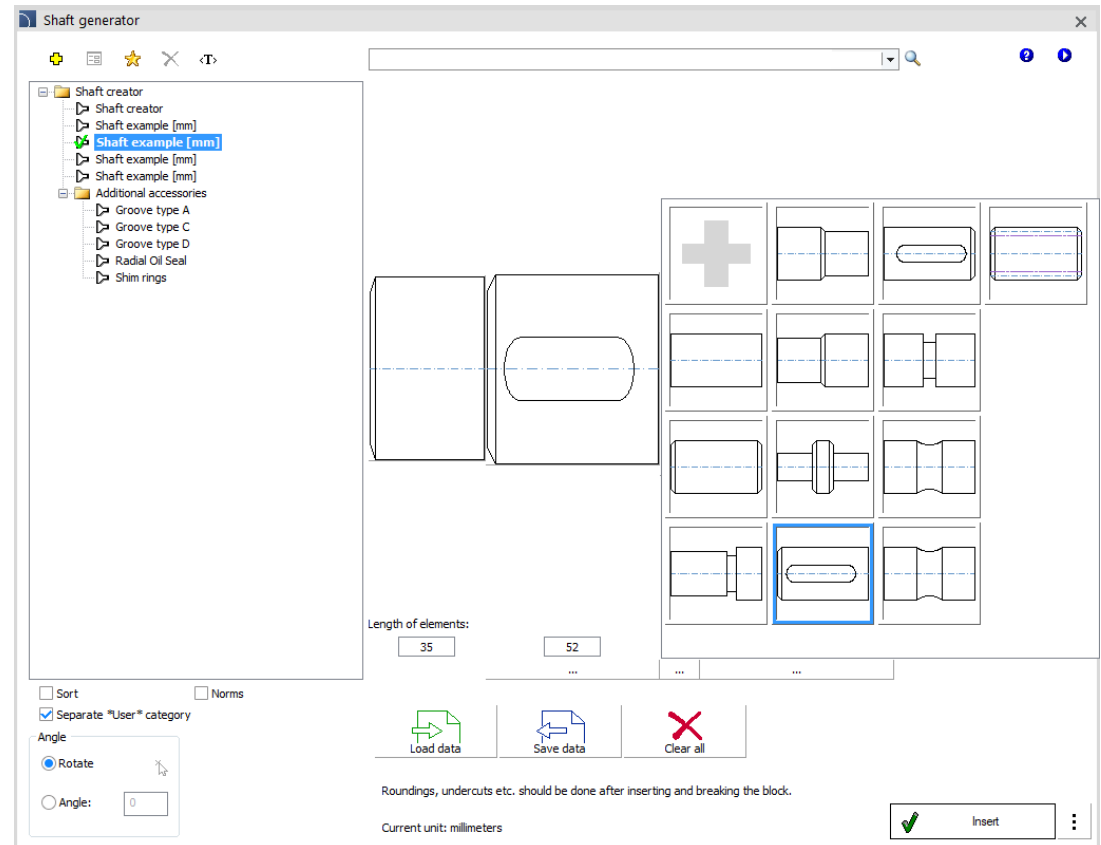

[Watch movie](#)



✓ CADprofi Mechanical – additional national standards

The **Steel shapes**  and **Standardized parts**  commands have been extended with products prepared in accordance to the following national standards:

- Czech Standards (CSN)
- Slovak Standards (STN)
- French Standards (NF)
- Swedish Standards (SS)
- Finnish Standards (SFS)
- Italian Standards (UNI)
- British Standards (BS)

Above national standards have been implemented for the following elements:

- screws,
- nuts,
- passage holes for screws,
- threaded holes,
- small screws,
- pins,
- bolts,
- cotters,
- steel sections,
- rods and steel pipes.

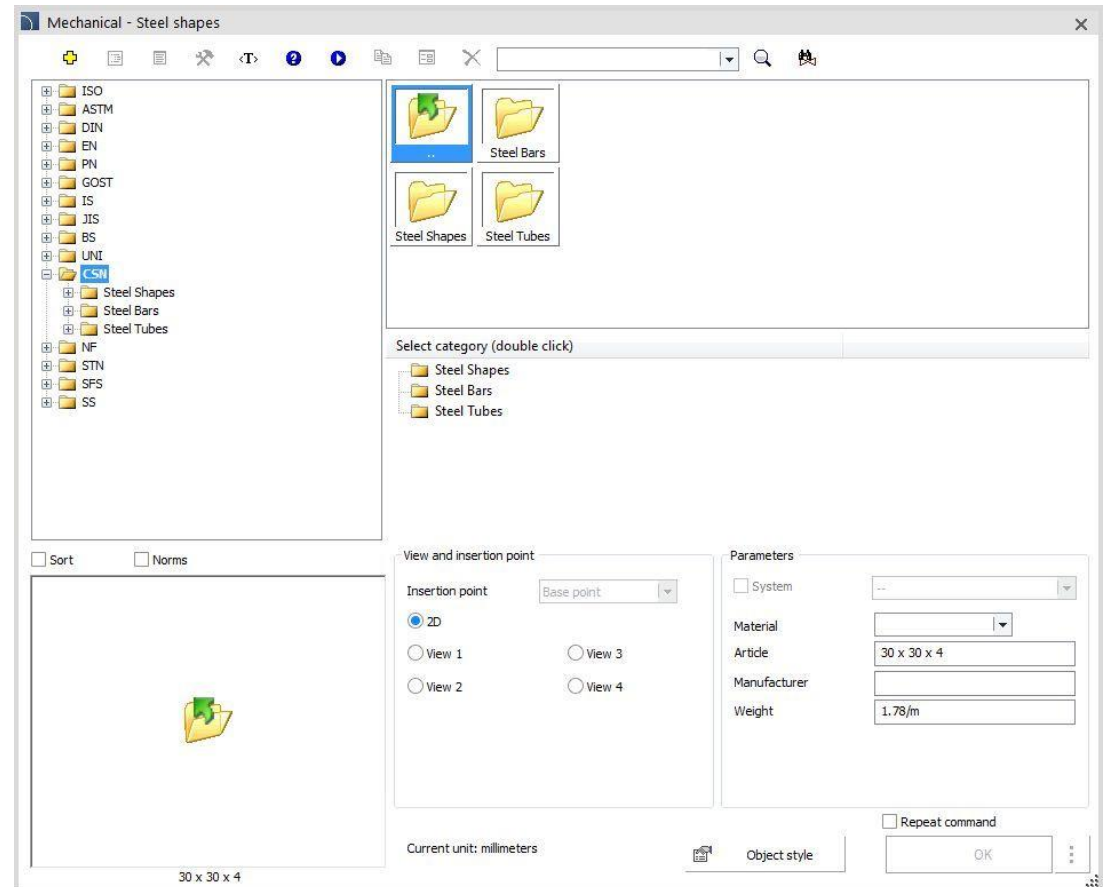

✓ CADprofi Mechanical – extension of the "Steel shapes" command

Straight and bent steel bars available in the *Steel shapes* command have been extended with new possibilities, including:

- ability to draw elements one after the other without interruption (creating a sequence of elements),
- ability to draw straight elements with elbows (creating a sequence of bent elements).

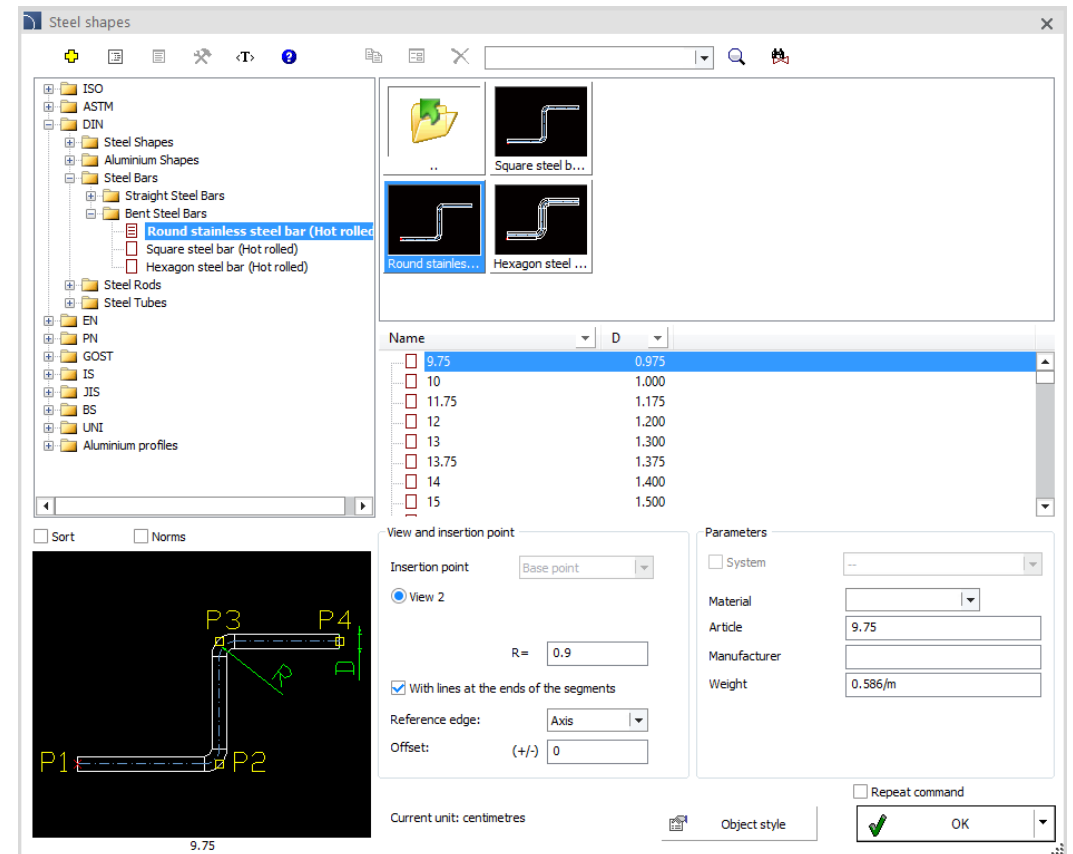
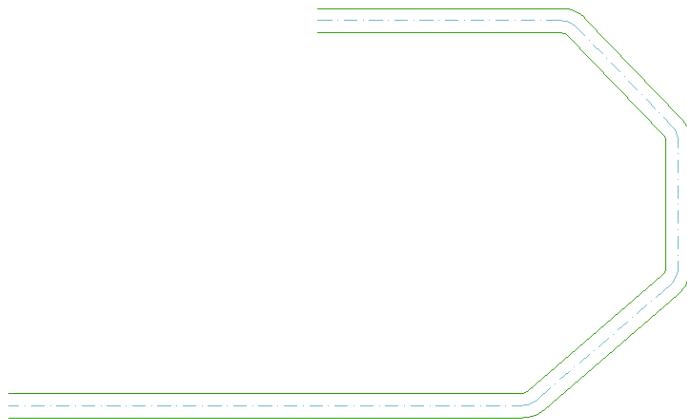

✓ CADprofi OEM – new AH-Hardt library

A lightning protection installation design system using *AH-Hardt* products has been added to CADprofi.

Library contains:

- Control boxes.
- Masts and spiers.
- Clamp holders & tensions systems.
- Horizontal terminals and discharge pipes.
- Ring, foundation and pin earthing.
- Connectors – cross, through, universal, control, ground, compensation etc.
- Accessories and add-ons.

Additionally program enables the design of installations in four LPS protection classes and the determination of mast protection zones using the cone method (protective angle) for one mast, as well as the rolling ball method for one mast and dynamically for many masts.



[Watch movie \(in PL language with EN subtitles\)](#)

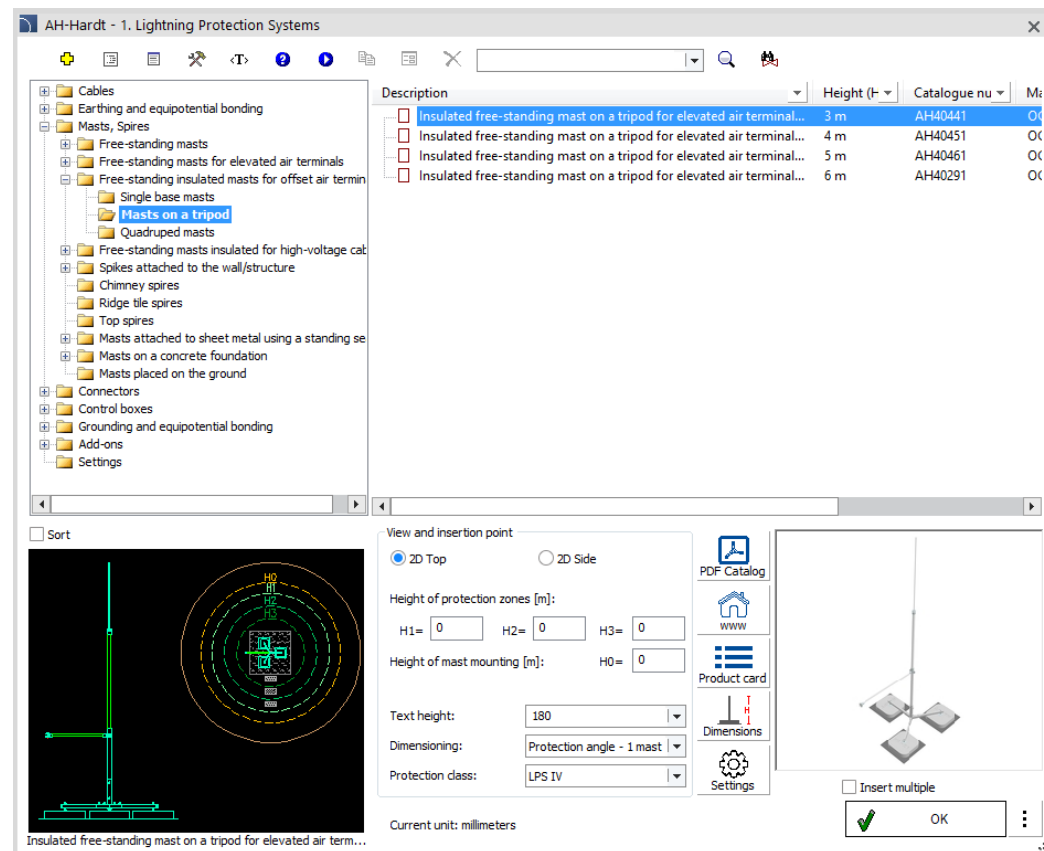

✓ CADprofi OEM – new El-Sun library

A system for designing lightning protection installations by using *El-Sun* products was introduced to the CADprofi program. The library contains:

- Horizontal terminals and discharge pipes.
- Connectors – universal, parallel, cross, through, wire-rod, wire-hoop, hoop-hoop, gutter.
- Clamp holders.
- Masts and spiers.
- Control boxes and connectors.
- Ring, foundation and pin earthing.
- Accessories and add-ons.

Additionally, program enables the design of installations in four LPS protection classes and the determination of mast protection zones using the cone method (protective angle) for one mast, as well as the rolling ball method for one mast and dynamically for many masts.

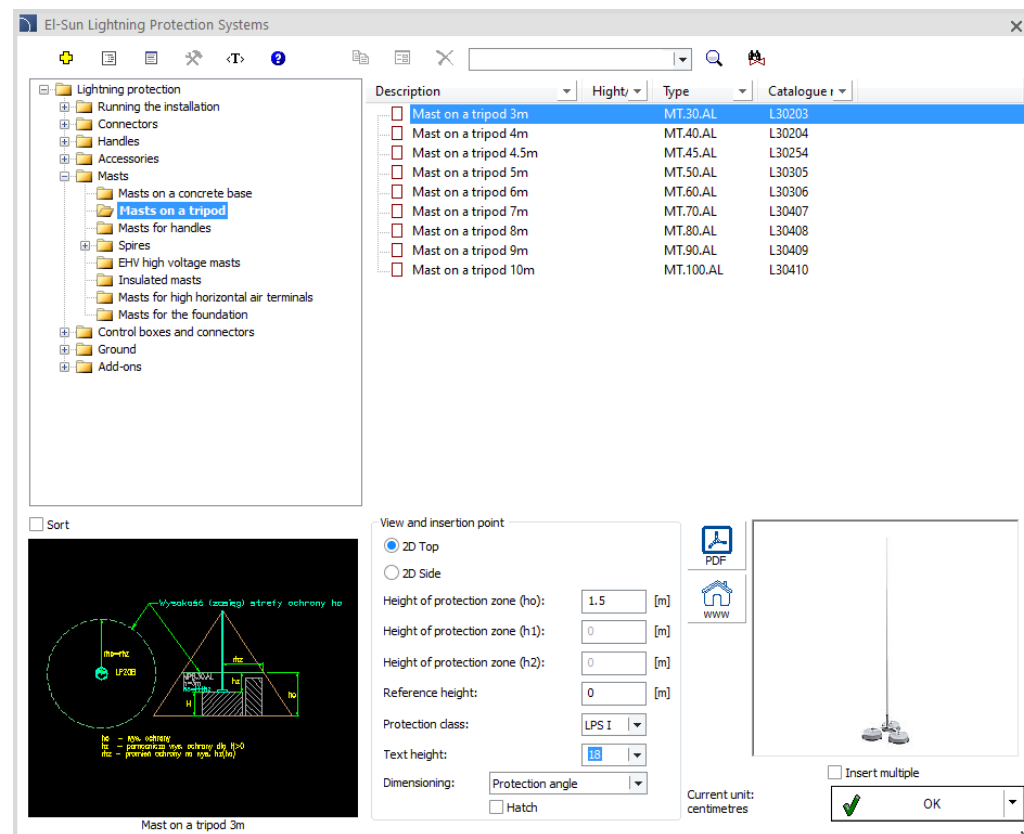



Description	Height	Type	Catalogue
<input type="checkbox"/> Mast on a tripod 3m		MT.30.AL	L30203
<input type="checkbox"/> Mast on a tripod 4m		MT.40.AL	L30204
<input type="checkbox"/> Mast on a tripod 4.5m		MT.45.AL	L30254
<input type="checkbox"/> Mast on a tripod 5m		MT.50.AL	L30305
<input type="checkbox"/> Mast on a tripod 6m		MT.60.AL	L30306
<input type="checkbox"/> Mast on a tripod 7m		MT.70.AL	L30407
<input type="checkbox"/> Mast on a tripod 8m		MT.80.AL	L30408
<input type="checkbox"/> Mast on a tripod 9m		MT.90.AL	L30409
<input type="checkbox"/> Mast on a tripod 10m		MT.100.AL	L30410

✓ CADprofi OEM – new Strawa library

Strawa library enables automatic selection of devices, performing hydraulic calculations and generating extended installation diagrams, as well as generating diagrams of boiler rooms and other heat sources along with buffer systems. The library facilitates the development of optimal solutions for heating and sanitary installations, offering the following possibilities:

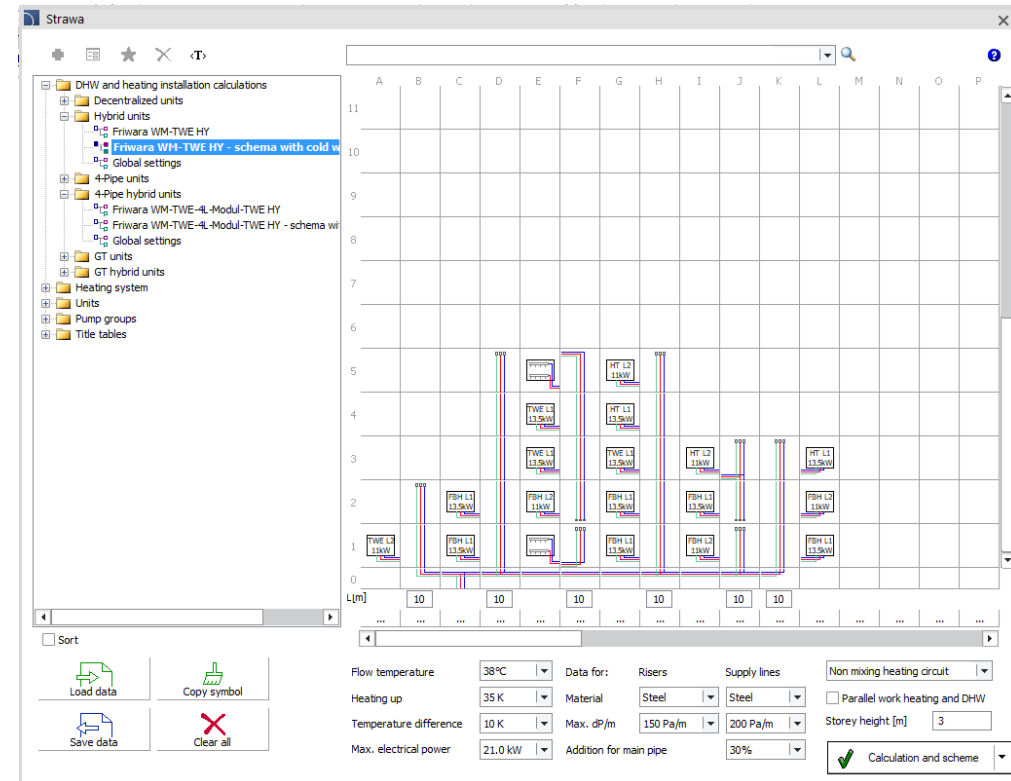
- Instant selection of receivers (residential stations and distributors) in the installation scheme creator window.
- Set heating power and/or domestic hot water demand separately for each receiver.
- Determining the general parameters of the installation and choosing the method of calculation.
- Selection of the type of pipes for risers and supply lines.
- Possibility to design installations for 2-wire and 4-wire stations.
- Calculating the actual demand for thermal power while taking into account the heater power in hybrid stations.
- Full hydraulic calculations with selection of pipe diameters, flow rates and determination of pressure drops.
- Calculation of the heat source power and peak power for domestic hot water.
- Selection of buffer sizes and pump types, i.e. buffer loading pump and circulation pump.
- Automatic drawing of heating installation layouts.
- List of pipe quantities.
- Multi-variant selection of elements in the boiler room diagram creator window, including: heat sources, number and arrangement of buffers (serial, Tichelmann or switched), pump groups, etc.



✓ CADprofi OEM – new Taconova library

Taconova library has been introduced into the CADprofi program and enables automatic selection of devices, performing hydraulic calculations and generating expanded installation diagrams. This tool supports the designer in order to prepare heating and sanitary installations. Library allows user to:

- Instant selection of receivers (residential stations and distributors) in the installation scheme creator window.
- Set heating power and/or domestic hot water demand separately for each receiver.
- Determining the general parameters of the installation and choosing the method of calculation.
- Selection of the type of pipes for risers and supply lines.
- Possibility to design installations for 2-wire and 4-wire stations.
- Full hydraulic calculations with selection of pipe diameters, flow rates and determination of pressure drops.
- Calculation of the heat source power and peak power for domestic hot water needs.
- Selection of buffer sizes and pump types, i.e. buffer loading pump and circulation pump.
- Automatic drawing of installation layouts.
- Specification of pipe quantities.

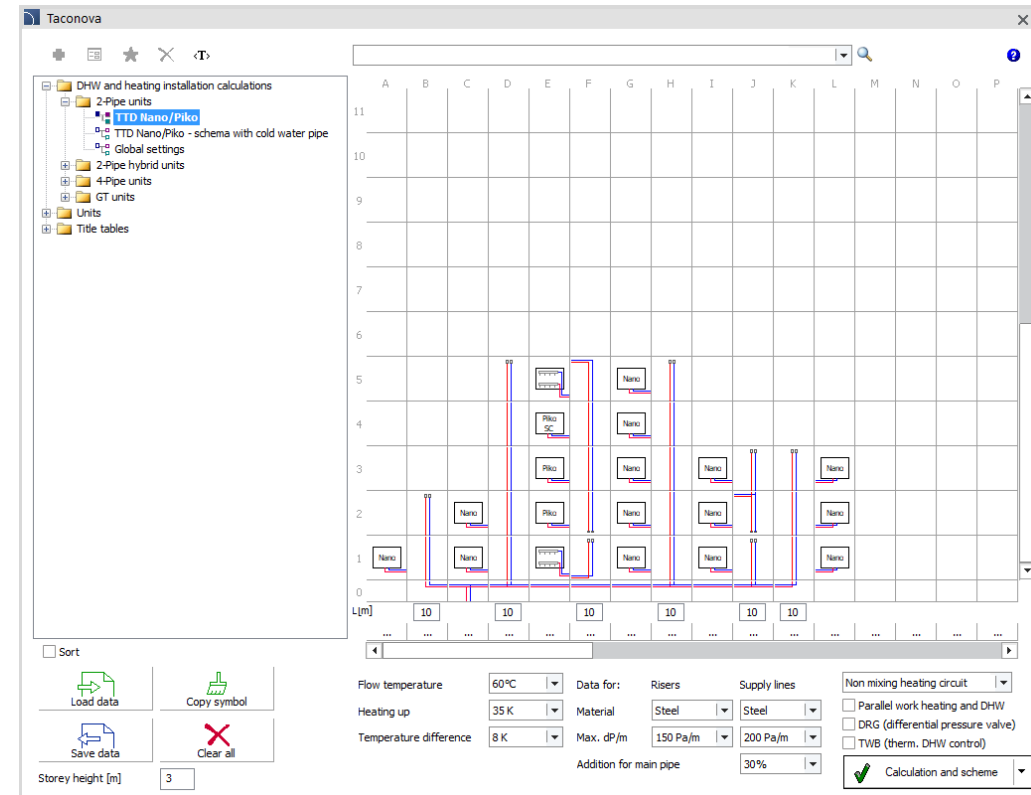

✓ CADprofi OEM – new Uponor library

The *Uponor* library, which is a continuation of the *KaMo* library after rebranding has been added to CADprofi. This tool enables automatic selection of devices, performing hydraulic calculations, as well as generating installation schemes, including boiler room diagrams and other heat sources along with buffer systems. The library facilitates the development of optimal solutions for heating and sanitary installations, offering the following possibilities:

- Quick selection of receivers (residential stations and manifolds) in the installation diagram creator window.
- Setting the heating power and/or DHW demand separately for each receiver.
- Defining general installation parameters and selecting the method of performing calculations.
- Selecting the type of pipes for risers and supply pipes.
- Possibility to design installations using a wide range of high- and low-temperature (hybrid) stations from the Aqua Port and Combi Port series.
- Full hydraulic calculations with the selection of pipe diameters, flow rates and determining pressure drops.
- Calculation of heat source power & peak power for DHW.
- Selection of buffer sizes and pump types, i.e. buffer loading pump and circulation pump.
- Automatic drawing of heating system developments.
- Specifications of pipe quantities.
- Preparation of boiler room schemes in the creator window, with multi-variant selection of heat source, number and buffer layout (serial, Tichelmann, switched), pump groups, etc.

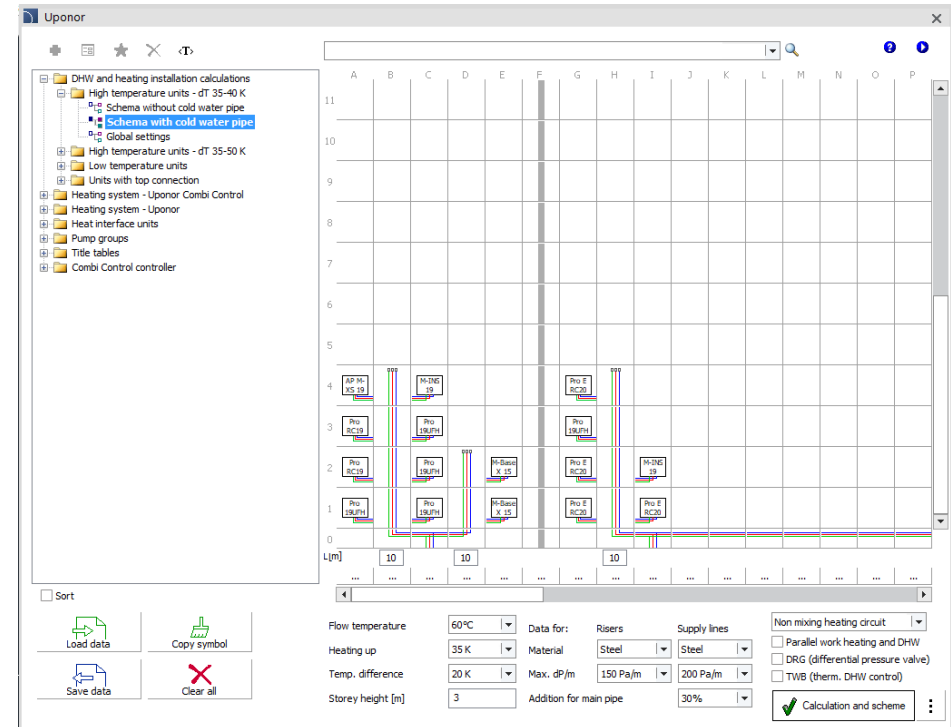

✓ CADprofi OEM – Schneider Electric power distribution scheme creator

Schneider Electric library available in CADprofi has been extended with the ability to generate schemes using the power distribution scheme creator.

Scheme creator allows user to select products available in the modular equipment library and place them in specific positions in the scheme.

In this way, user can very easily and quickly define the logical structure of the entire switchboard, focusing only on the selection of products, and not on manual drawing.

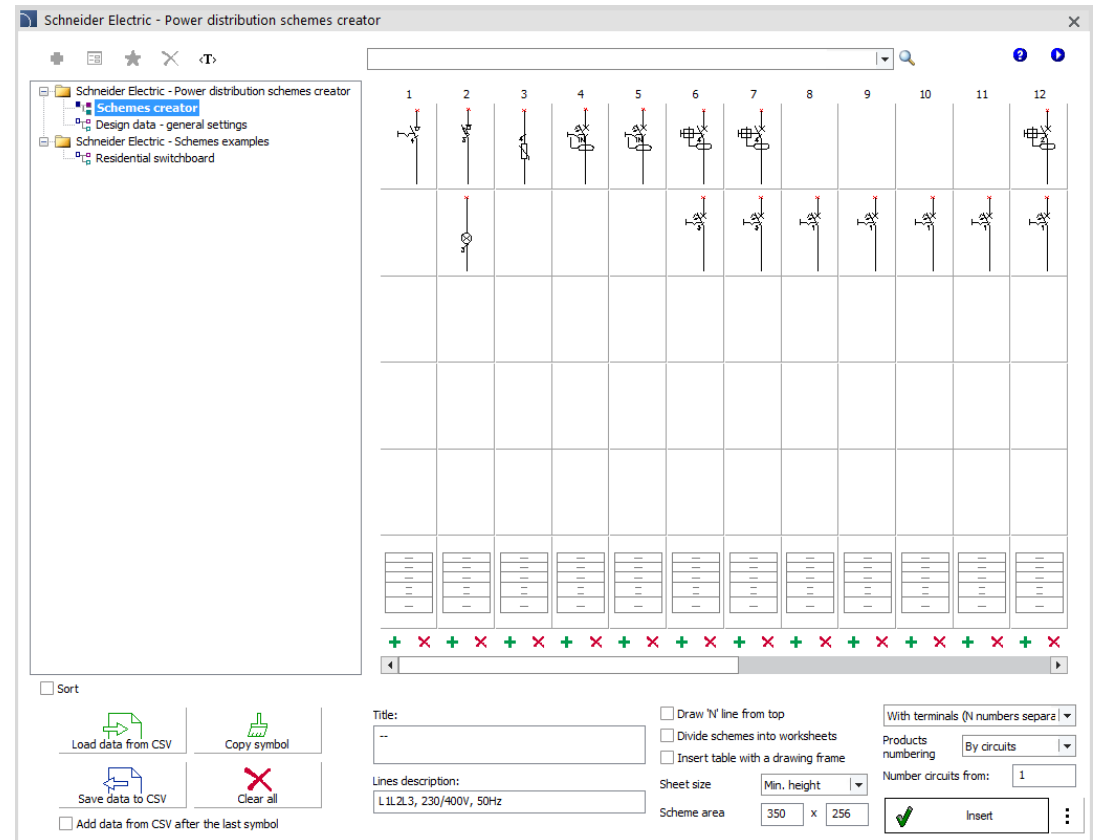

✓ CADprofi OEM – extension of the Hager library

Hager library has been expanded with a new series of hw+ air circuit breakers and switch disconnectors:

- air circuit breakers in fixed and withdrawable versions;
- air switches in stationary and withdrawable versions;
- elements of the univers NHC building system;
- additional accessories: shunt and undervoltage releases, closing coils, motor drives, auxiliary and signaling contacts, mechanical interlocks.

Hager library is only available in Polish language.

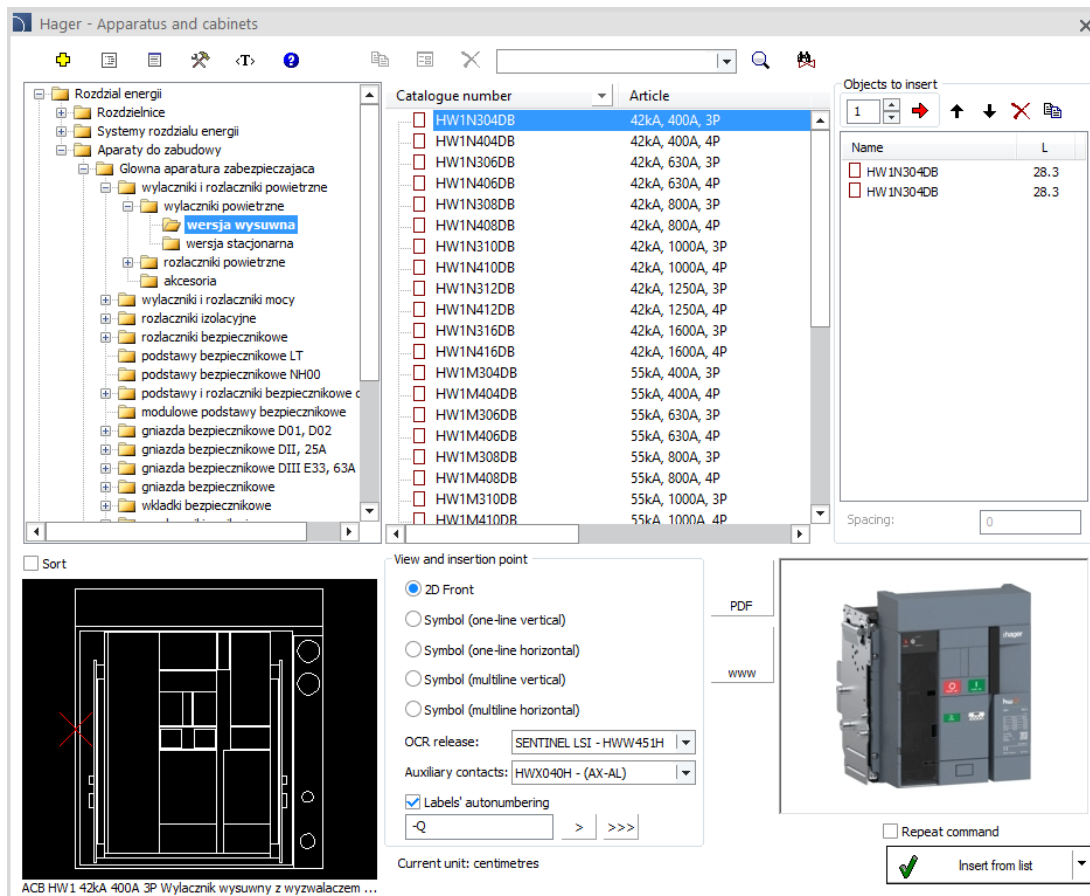
The screenshot shows the Hager CAD software interface with the following components:

- Left Panel:** A tree view of the library structure, including folders like "Rozdzielnice", "Systemy rozdzielni energii", and "Aparaty do zabudowy". The "wersja wysuwana" folder is selected.
- Center Panel:** A table listing various circuit breaker models and their specifications.

Catalogue number	Article
HW1N304DB	42kA, 400A, 3P
HW1N404DB	42kA, 400A, 4P
HW1N306DB	42kA, 630A, 3P
HW1N406DB	42kA, 630A, 4P
HW1N308DB	42kA, 800A, 3P
HW1N408DB	42kA, 800A, 4P
HW1N310DB	42kA, 1000A, 3P
HW1N410DB	42kA, 1000A, 4P
HW1N312DB	42kA, 1250A, 3P
HW1N412DB	42kA, 1250A, 4P
HW1N316DB	42kA, 1600A, 3P
HW1N416DB	42kA, 1600A, 4P
HW1M304DB	55kA, 400A, 3P
HW1M404DB	55kA, 400A, 4P
HW1M306DB	55kA, 630A, 3P
HW1M406DB	55kA, 630A, 4P
HW1M308DB	55kA, 800A, 3P
HW1M408DB	55kA, 800A, 4P
HW1M310DB	55kA, 1000A, 3P
HW1M410DB	55kA, 1000A, 4P
- Right Panel:** "Objects to insert" section showing a list of selected items:

Name	L
HW 1N304DB	28.3
HW 1N304DB	28.3
- Bottom Left:** A 2D front view of a circuit breaker symbol with a red 'X' indicating the insertion point.
- Bottom Center:** "View and insertion point" settings, including options for "2D Front", "Symbol (one-line vertical)", "Symbol (one-line horizontal)", "Symbol (multiline vertical)", and "Symbol (multiline horizontal)". It also shows settings for "OCR release" (SENTINEL LSI - HWW451H) and "Auxiliary contacts" (HWW40H - (AX-AL)).
- Bottom Right:** A 3D rendering of the selected circuit breaker unit.

✓ CADprofi OEM – extension of the Hager power distribution scheme creator

“Hager - power distribution scheme creator” library has been expanded with measurement system templates with transformers in the following configurations:

- network parameter analyzer with current transformers, fuse device or circuit breaker,,
- energy meter with current transformers, fuse device or circuit breaker.

Hager library is only available in Polish language.

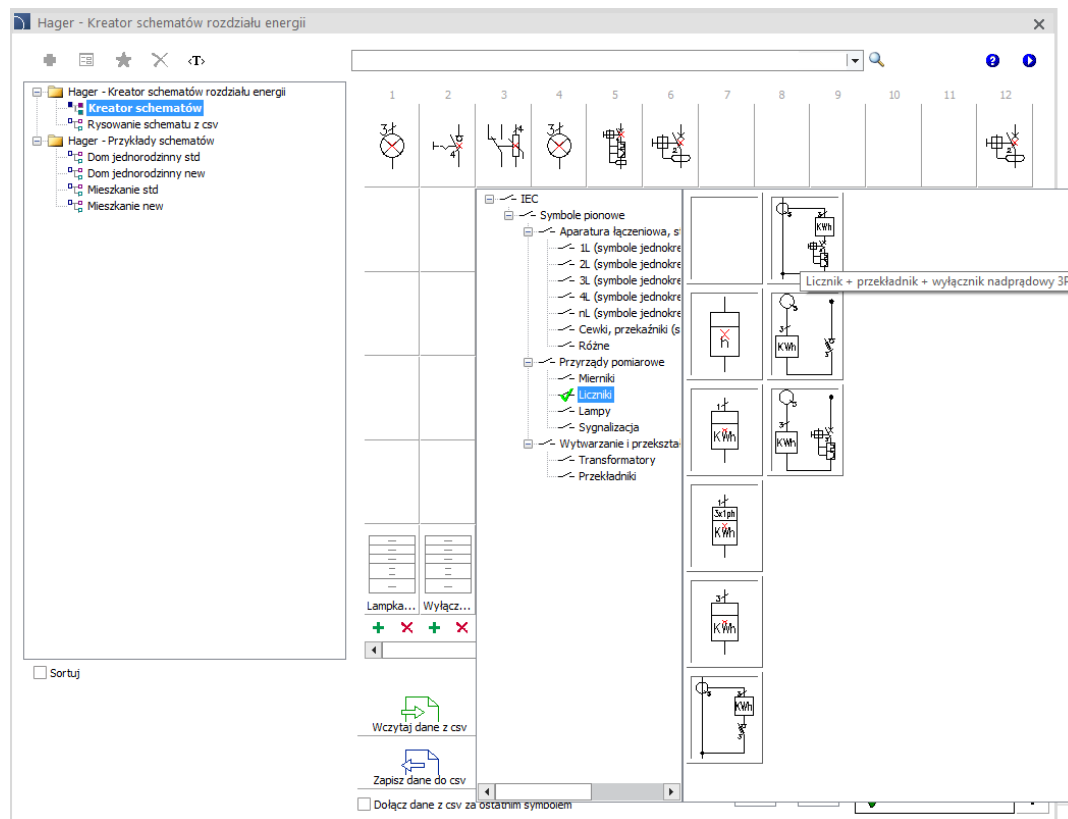

✓ CADprofi OEM – extension of the ETI library

ETI product library has been updated and expanded with new products in the field of low-voltage equipment and switchgears.

Additionally, the product selection dialog window has been extended with the ability to quickly go to the PDF catalog and the manufacturer's website with product information.

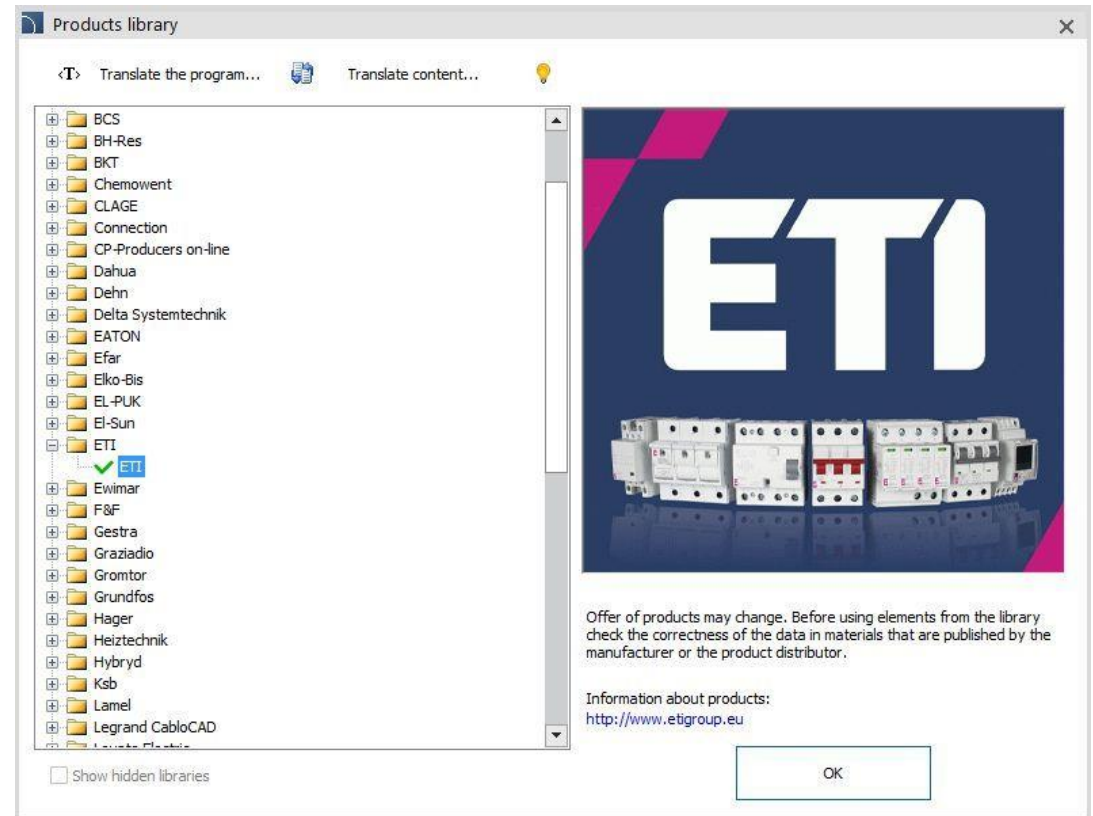
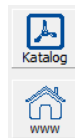

✓ CADprofi OEM – extension of the Reflex library

The Reflex library has been extended with new type of series for the following products:

- buffer tanks Mini V..., Mini H...,
- accesories for the domestic hot water preparation station Hydroflow,
- pressure stabilization systems of series Reflexomat RS,
- Hydroflow domestic hot water preparation stations, SF buffer tanks and Reflexomat Silent Compact Smart (RSC Smart).

Additionally, the product selection window has been extended with the ability to quickly go to:

- manufacturer's website,
- selected product directly in the web catalog,
- product cards in PDF format.

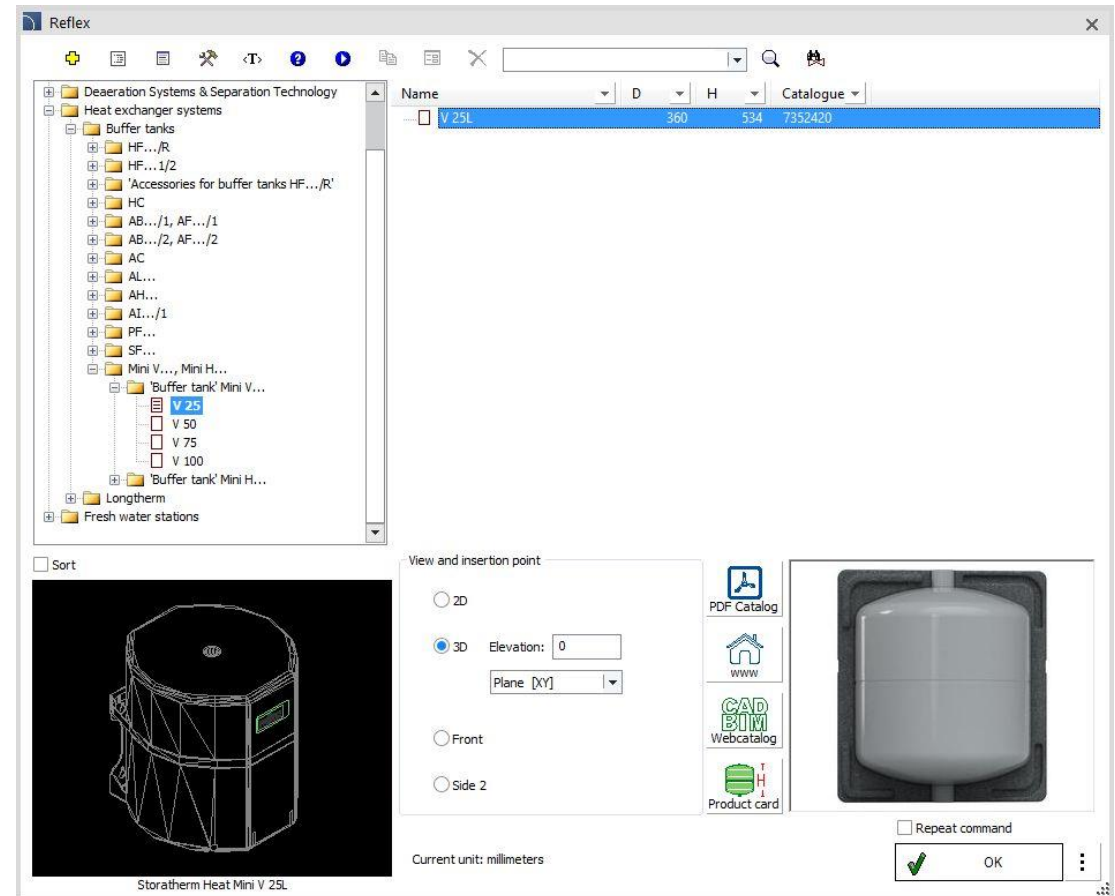

✓ CADprofi OEM – extension of the Noark Electric library

The *Noark Electric* library has been expanded with new products, including:

- flush-mounted and surface-mounted installation casings made of plastic, metal and multimedia;
- distribution blocks;
- distribution blocks;
- service sockets;
- connecting busbars;
- insulating terminals;
- terminal blocks;
- chargers for electric cars.



Additionally, the library has been expanded to include the ability to automatically select cabinets based on the devices used in the project and to determine the size of labels for products.



Choose an Noark Electric cabinet for the selected apparatus from the drawing

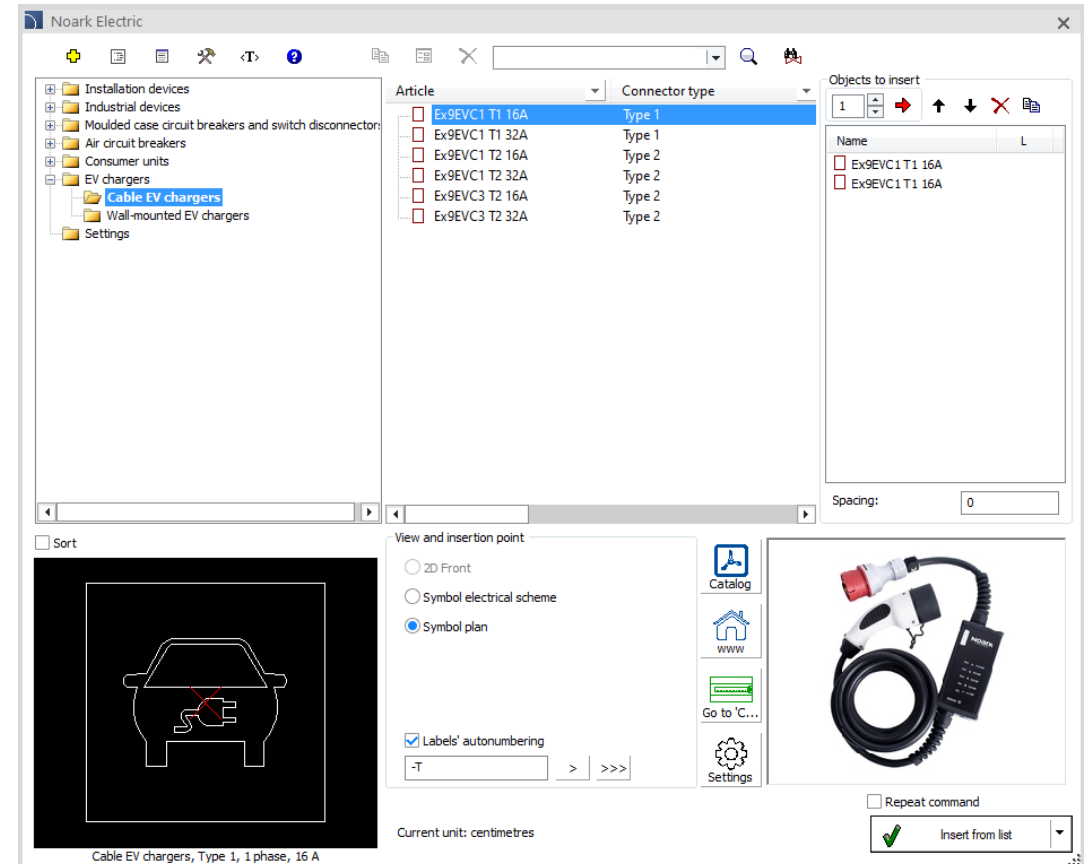



CADprofi

✓ Update of product libraries:





CADprofi

✓ Adjustment to many base CAD programs

CADprofi program version 2025.01 has been adjusted to work with latest CAD programs, including: AutoCAD 2025, AViCAD 2025, BricsCAD 2025, CADian 2024, CADdirect 2025, CMS IntelliCAD 13.0, GstarCAD 2025, IntelliCAD 12.0, INTERsoft-INTELLICAD 2024, ZWCAD 2025.

Program CADprofi 2025 currently works with many base CAD programs CAD, including: AutoCAD (since 2004 version), BricsCAD, GstarCAD, progeCAD, ZWCAD, ARES Commander.

The logo for AutoCAD, featuring the word 'AutoCAD' in a bold, red, sans-serif font with a registered trademark symbol.

The logo for ZWCAD, featuring the word 'ZWCAD' in a bold, blue, sans-serif font with a green leaf-like graphic above the 'W'.

The logo for GstarCAD, featuring the word 'GstarCAD' in a bold, blue, sans-serif font with a yellow 'A', and the tagline 'An Alternative CAD System' in a smaller blue font below it.

The logo for BricsCAD, featuring a stylized blue 'B' shape above the word 'BRICSCAD' in a bold, blue, sans-serif font.

The logo for progeSOFT, featuring a blue globe with a yellow 'I' shape inside, above the word 'progeSOFT' in a blue, sans-serif font.

The logo for IntelliCAD, featuring a purple diamond shape with a yellow 'I' shape inside, above the word 'IntelliCAD' in a bold, purple, sans-serif font.

The logo for Gräbert ARES Commander, featuring a red flame-like graphic above the word 'Gräbert' in a small black font, and 'ARES® Commander' in a large, bold, black, sans-serif font.